



METALWORKS® Machine-Room Solution

天玑解决方案（机房专用）

- Ceiling is an important part of the machine room that can change the environment into comfortable spaces without noise, optimizes the sound attenuation performance room to room. METALWORKS Machine-Room Solution is a solution specially offer the option for ceilings and wall solutions.
- 机房设备需要安全可靠的运行要求，同时创造一个舒适、没有噪音的环境。吊顶是机房重要的组成部分。现代机房要求吊顶材料防火、防尘、美观和易于拆卸。阿姆斯壮天玑解决方案（机房专用）是专为机房配套的解决方案，可用于吊顶及墙面系统。





产品特性：

- 15mm FG acoustical infill ceilings and wall solution can significantly improve the NRC(0.9) and ensure a safe and comfortable machine room space
采用金属复合玻纤吸音吊顶与墙面系统，可以显著提升天花系统的吸音性能，NRC高达0.9，营造静谧舒适的室内空间
- The ceiling system can cover various metal pipe grooves and fire extinguishing system etc, beautifies the environment and improves the environment of the machine room.
吊顶遮盖了强弱电及各类金属管槽，消防报警及灭火系统各类管线，美化了环境，提升了机房的整体效果。
- simple panel removal and enough plenum access, ease of installation and maintenance.
吊顶净空可兼顾机房高度与装修后净空高度，易于维护保养。
- Excellent anti-humidity & fire reaction ensure
出色的防潮及防火性能，确保使用安全

METALWORKS® Machine-Room Solution

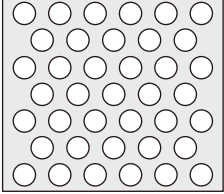
天玑解决方案（机房专用）

产品参数 Product Data:

吸音孔型 Perforation	高吸音孔 (RV 3136) Acoustical Perforation		
			
Diameter 孔径	3.12mm		
Open Area 开孔率	36%		
 NRC 降噪系数	NRC 0.9		
 Standard Size 标准尺寸 (WxL)	600X600mm (766815) 300X300mm (766808)		
复合材质 Infilled Material	15mm FG infill 15mm高吸音玻纤复合板		
表面材质 Material	Hot-dipped Galvanized Steel 热镀锌钢		
表面喷涂 Coating	后喷涂 Post-coating	安装方式	直角暗架卡夹式
颜色选择 Color		质保 Warranty	10年
 Suspension System 龙骨系统	<ol style="list-style-type: none"> 1. 圆头A字卡夹式龙骨 (767651) 2. 方头A字卡夹龙骨 (767650) 3. 龙骨墙面固定件 (767649) 4. 圆头A字卡夹式龙骨吊件 (767648) 5. A字卡夹龙骨连接件 (767647) 		

吊顶安装示意图

墙面安装示意图

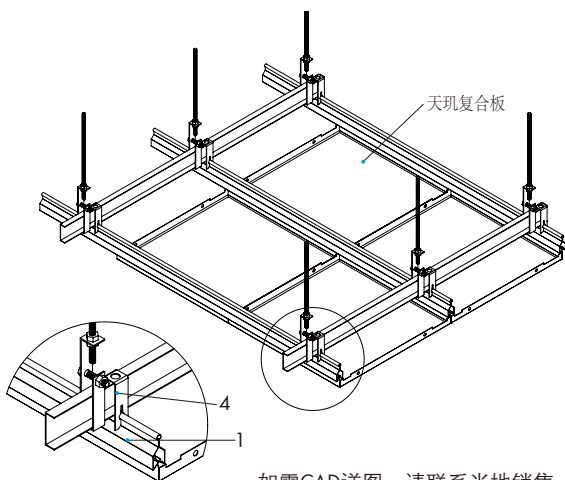

如需CAD详图，请联系当地销售

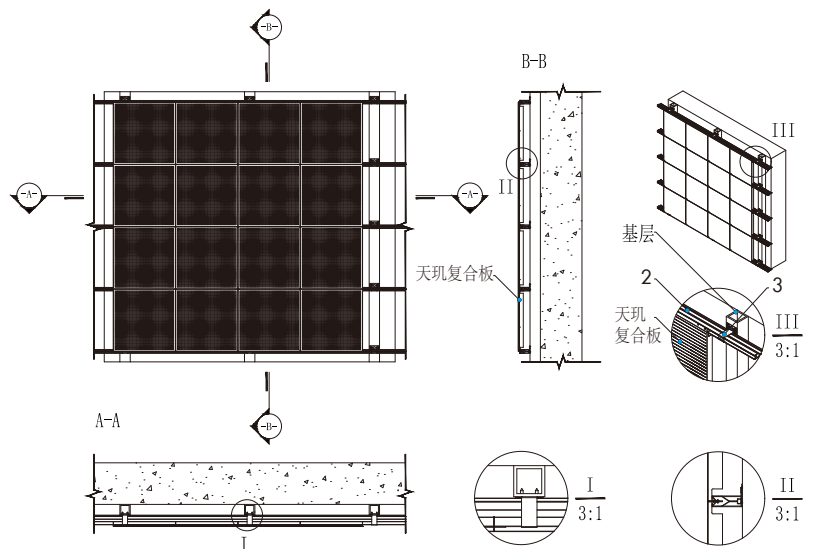

扫描二维码
获取详细的产品信息



关注阿姆斯壮天花公众号
获取更多精彩内容

www.knaufceilingsolutions.com

免费咨询热线: 400-779-3366

05-2022 Printed in Shanghai

Armstrong®
CEILING SOLUTIONS